

Starfield Tool List

1. Drill Bits (3 are included in kit)
2. Cordless Screwgun
3. Razor Knife
4. 1" Spade Bit
5. Stud Finder
6. Glue (Elmer's)
7. Tape Measure
8. Painter's Tape
9. Side Cutters
10. Flashlight
11. Phillips Head Screwdriver

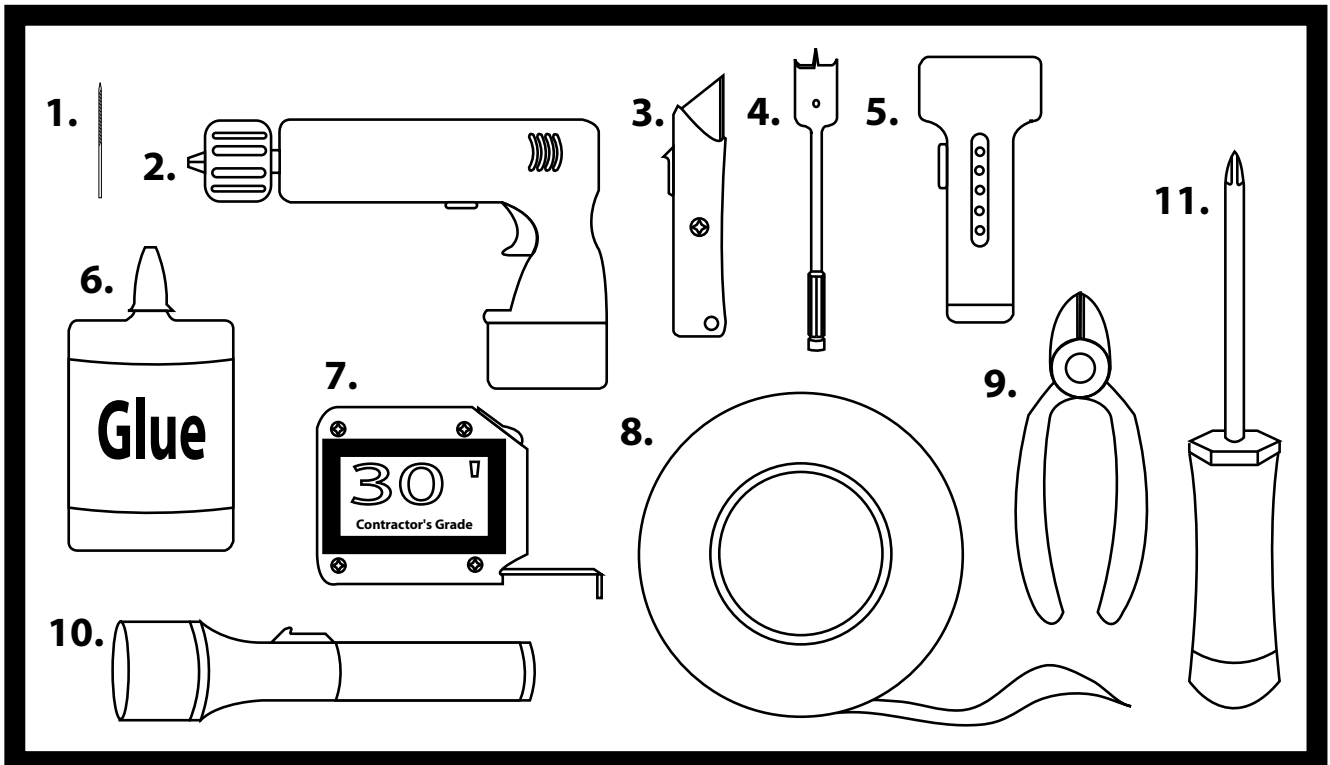

Preparing Install

(Section 1)

1. Decide what room you would like to install the starfield kit in and is it a candidate for a standard install.

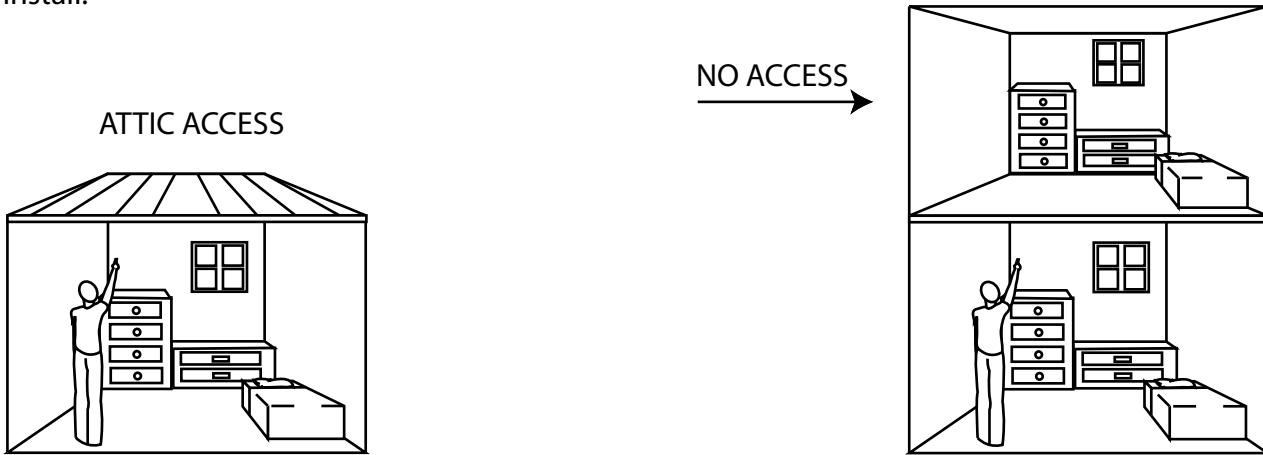

2. Using a stud finder, locate the studs in the ceiling. Then mark with a pencil. Next take the painter's tape and adhere it to the ceiling where the studs are. This will keep you from drilling into the studs when you are ready to drill out for starfield. After you finish marking studs go into access above and double check.



3. For the shooting star kit only: Tape template to ceiling in desired location.

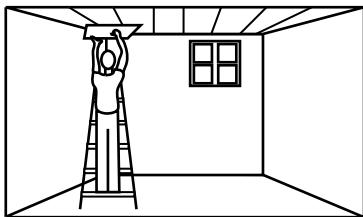

Installing

Section 2

1. Determine position for light source in such a way that fibers can reach from the light source to all corners of the room. Next, using your 1" spade bit and cordless screwgun drill holes in the side of the stud so that you may run your whips to each bay. (NOTE: You do not want to run your whips over the studs because items you might be storing in you attic can crush or even break fibers causing a loss of light.)

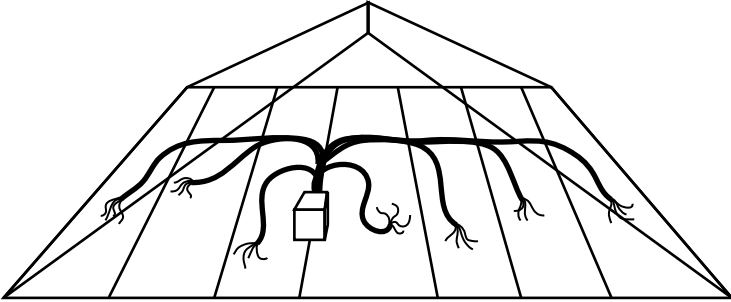

2. Figure out how many fibers you ran to each bay an either draw a diagram or commit to memory. This let you know how many holes you need to drill in the ceiling fo each marked bay.

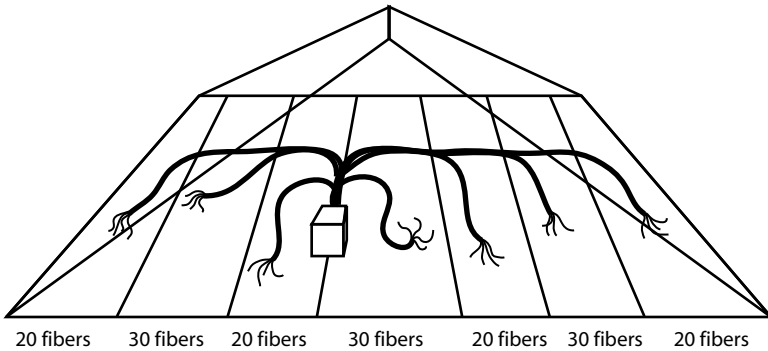

3. Drill out each bay with cordless screwgun and .01" drill bit. Also drill out shooting star for shooting star kit.

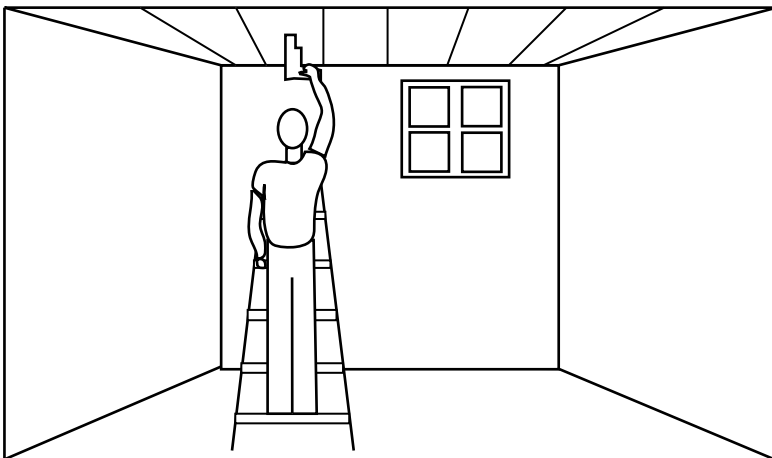

3. (NOTE: If you have not purchased the shooting star/starfield kit skip the following steps : 3 of Section 2 and How to Select Section.) Select the shooting star portion of the starfield kit and pull those fibers through the pre-drilled holes first.

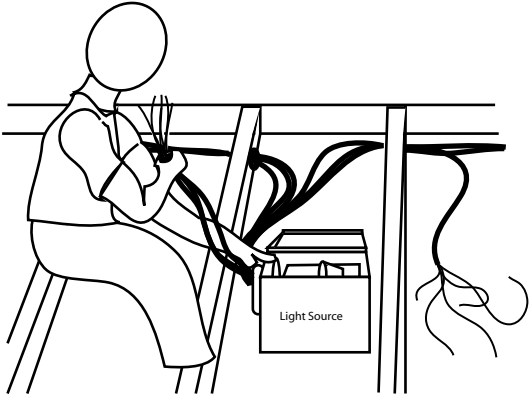

How to Select

A. Place fiber head into box ,lock head into place with set screw

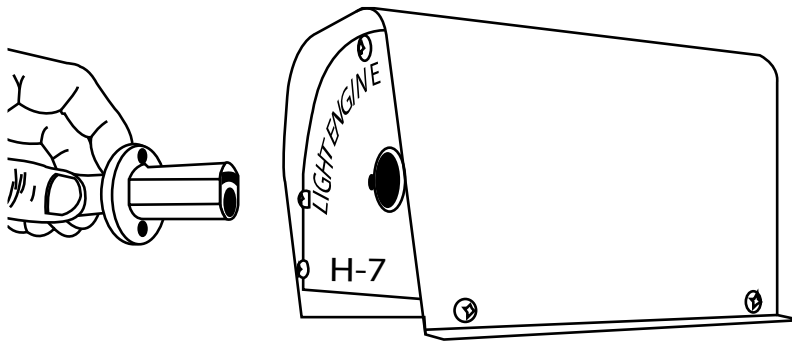

B. Open lightsource cover by removing the 13 exterior screws for housing using a phillips head screwdriver.

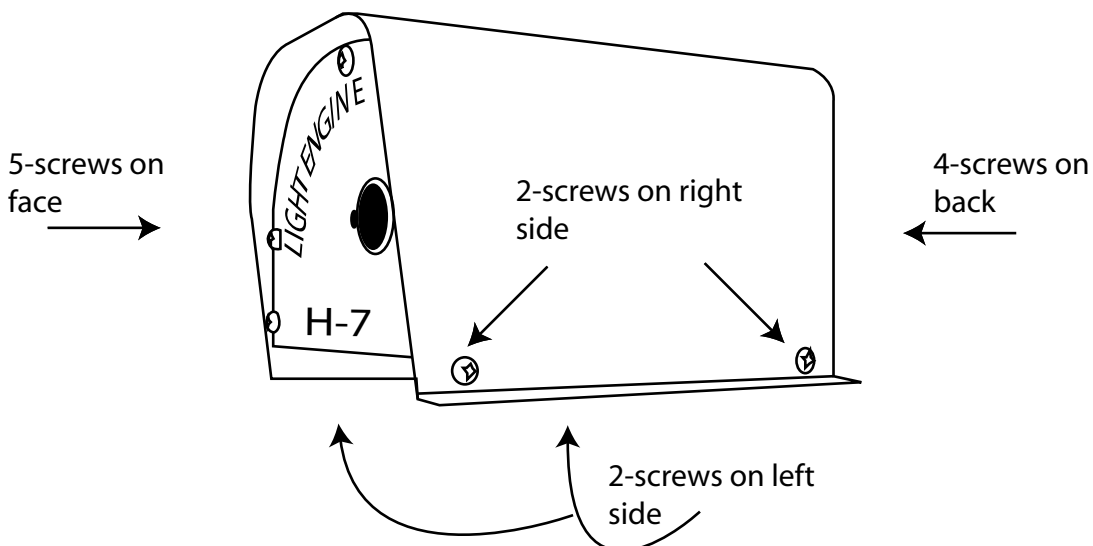

How to Select Cont.

C. Light source is now open. Turn light source on and motor switch. Determine the rotation of the motor. Once direction of rotation is determined turn motor switch off.

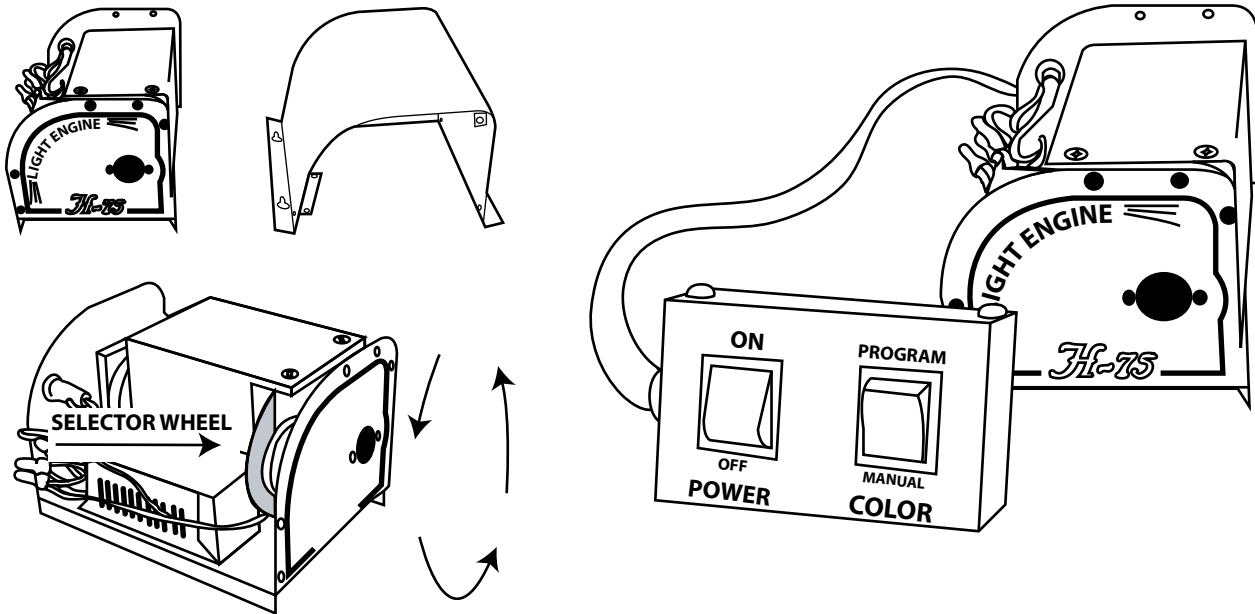

D. The starfield wheel has two types of cuts. One is the circular cuts in the center for the stars to twinkle and the other are the selector cuts on the outer part of the wheel.

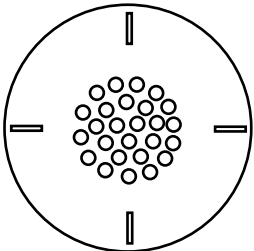

E. Hold the first two groups of fibers designated for the shooting star in one hand and manually spin the wheel with the other hand in the direction the motor rotates. The star fibers will then light in sequence. The first fiber that lights will be the first fiber you feed through the pre-drilled shooting star in the ceiling. (NOTE: fibers should be fed so that at least 1' is hanging through the ceiling.)

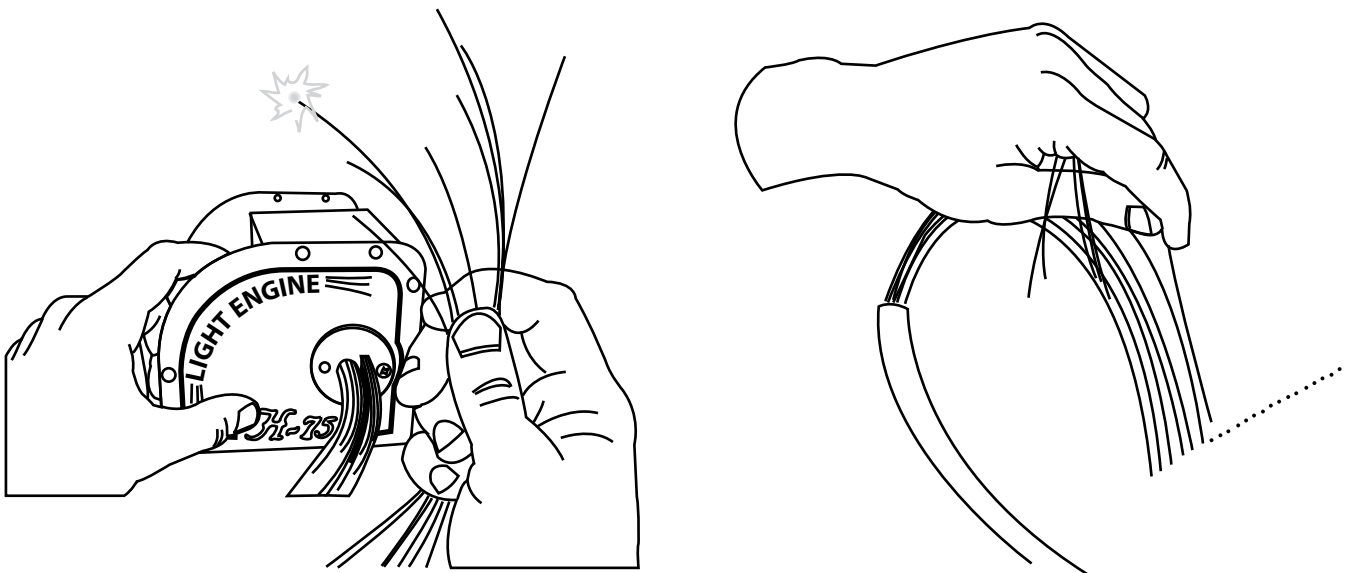

How to Select Cont.

F. Continue until all fibers designated for the shooting star are fed into the ceiling. Turn motor for starfield wheel on, go into room fibers are hanging in and check to make sure that you have sequenced correctly.

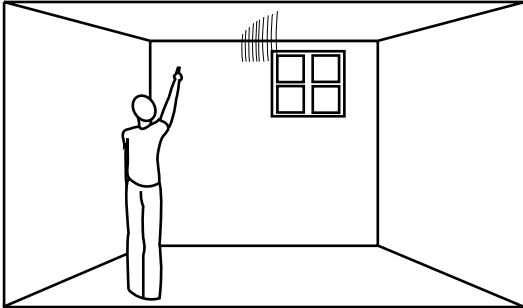

G. Once check is complete return to access area so that you may glue shooting star into place. (NOTE: Be sure to get plenty of glue around all fibers. Also feed fiber in and out approximately 1" so that glue coats fiber and fills any space in hole surrounding fiber.) Shooting star is now complete.

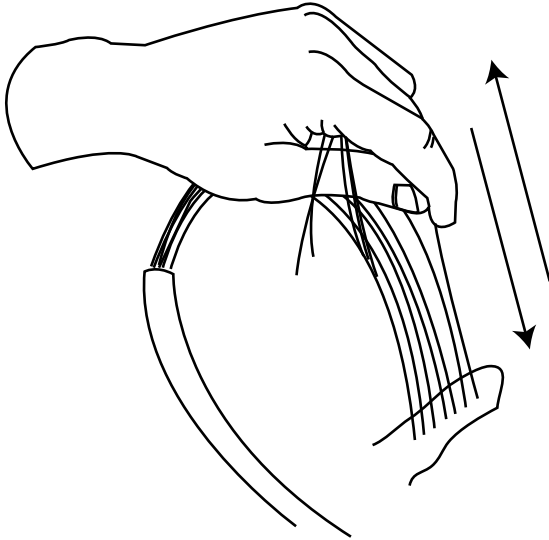

Installing

Section 2 Continued

4. Feed the rest of the fibers designated for the starfield through pre-drilled holes and glue as you go. (NOTE: Be careful when cutting back fiber jacket not to cut the fibers.)

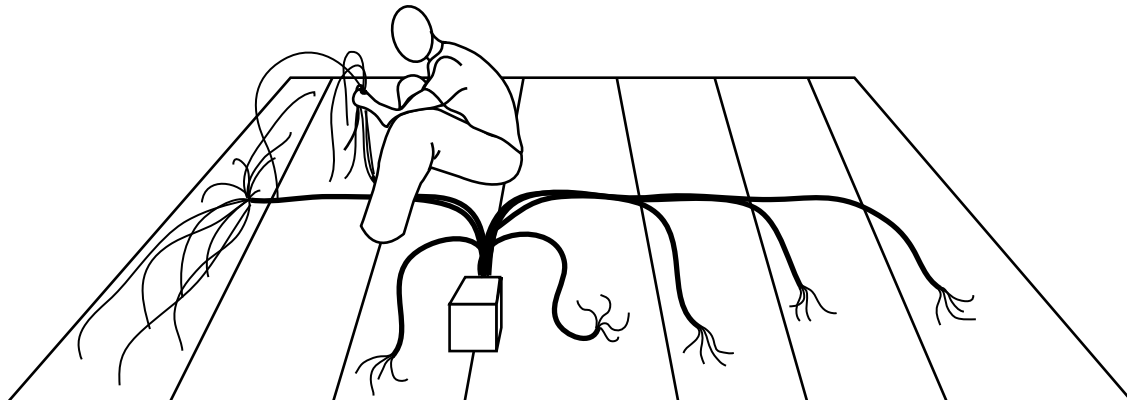

FINISHING

SECTION 3

1. If ceiling is dirty, clean before you cut the fibers back. (NOTE: Glue will not dry solid for 24 hours and sets in a couple of hours. Cleaning after you cut the fibers could cause some of the fibers to push back into the ceiling resulting in a loss of light.) If ceiling is clean or if you will clean after glue dries solid then you may proceed to cut fibers back 1/4" to 1/8" from the ceiling surface including shooting star. This allows for the future painting of the ceiling.



2. **Hit the wall switch and enjoy!** (NOTE: Wall switch and switched outlet should be installed by a qualified electrician.)



SHOOTING STAR TEMPLATE

70 PT.

