

250 Strand 4 Size Star White LED Fiber Optic Star Ceiling Kit



Technical Data

Power consumption: 7 Watts

Color: White

Twinkle Wheel (Installed)

Light Source: 7 Watt LED

Estimated Life of LEDs: 50000 hours

Fiber Bundle: Zip Tied Bundles For Faster Installation

Size: L125 x W126 x H 88mm (L 4.92 in x 5 in x 3.15 in)

Net weight of Light Engine: 0.6 Kg (1.4 lbs)

Fiber: 250 strands of either 8, 16, 20, 24, 28, or 30 feet long fiber optic cable. 168 fibers x 0.75mm + 48 fibers x 1.0mm + 24 fibers x 1.5mm + 10 x 2.0mm.



UL Rated
12VDC
Transformer
with US Plug.

Battery for the Remote: The battery for the remote is a 12 Volt 27A. The battery dimensions are 1" x .30" or 28mm x 8mm. **Note:** Be extremely careful when removing the three (3) tiny screws out of the remote. The screws are holding the entire remote casing together.

Installation

The installation dimension of the Light Engine.

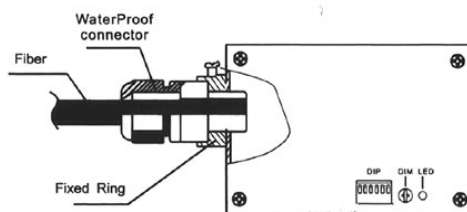
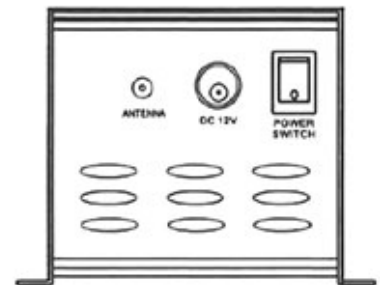
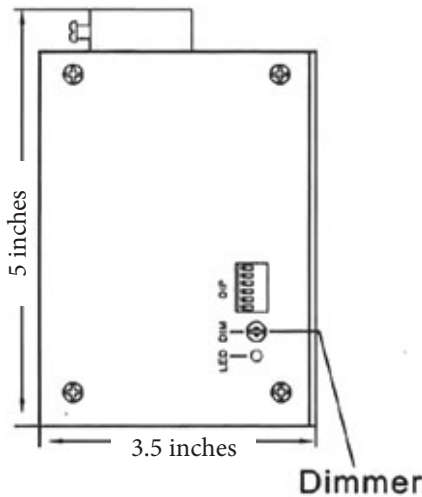
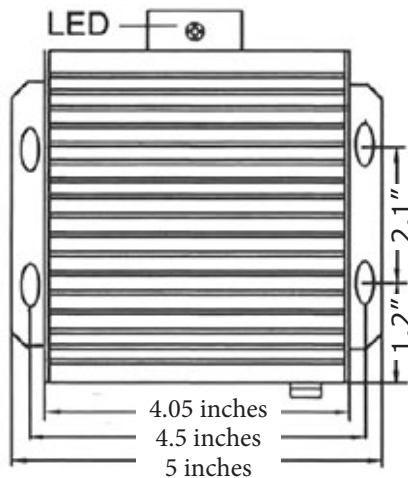

250 Strand 4 Size Star White LED Fiber Optic Star Ceiling Kit

Remote Control Operation

The power button is used to turn on and off the light engine.
To turn on the remote feature, set dip switch number 6 down to activate the remote controller.

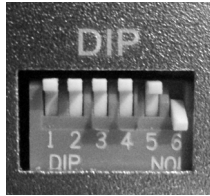

Manual Control for Twinkle Wheel Speed

Use the dip switches to select from 6 different speed levels. For the slowest speed dip switches 2 & 3 should be ON and 1, 4, and 5 switches set to OFF.

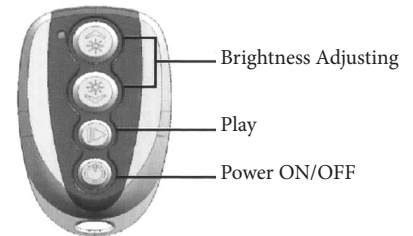
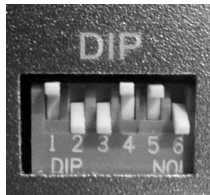

Note: The speed of the twinkle wheel is only controlled manually via the dip switches.

DIP Switch Chart

Pro. No.	DIP SWITCH (1=ON, 0=OFF)						EFFECT
	1	2	3	4	5	6	
00	0	0	0	0	0	0	Motor stopped, LED working
01	1	0	0	0	0	0	(6RPM)
02	0	1	0	0	0	0	(4RPM)
03	1	1	0	0	0	0	(2.5RPM)
04	0	0	1	0	0	0	(2RPM)
05	1	0	1	0	0	0	(1.5RPM)
06	0	1	1	0	0	0	(1RPM)

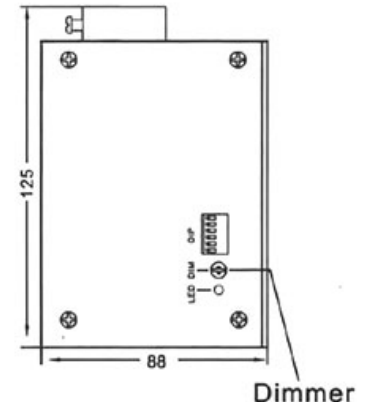

Notice: Rotations Per Minute (RPM) is the speed of the twinkle wheel.

Stopping the Twinkle Wheel with the Remote

As the twinkle wheel turns, press the Play button to stop twinkle wheel and have solid stars.

Dimming

The brightness buttons on the top of the remote allows you to adjust the brightness of the lighting at 8 levels. You can also adjust the lighting manually by using the dimming screw on the side of the light engine.

250 Strand 4 Size Star White LED Fiber Optic Star Ceiling Kit

Installation Of The Fiber Ends

Installer should stand on a ladder to unravel the fiber bundle as gravity will help free them up. Drill holes on the panel or ceiling you wish to install the fiber optic cables. Pull the fibers through the holes and use glue (we recommend using Elmer's All Multipurpose White Glue) to secure the fibers in place.

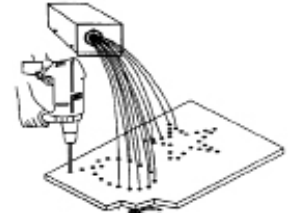

Safety Instructions:

1. Keep out of rain or moist areas to avoid shock hazards.
2. Avoid use in high temperatures (< 40°C or < 104°F).
3. Keep Light Engine in ventilated area.
4. The light engine has a safety feature that will turn the light engine off to prevent it from over heating.