

RF wireless LED remote controller

Model:SR-2818 with SR-1009Fxx



- Eight zones/areas
- Touch button RGB+W controller
- Chargeable by USB
- Receivers work with WIFI-RF converter to be controlled by smart phone



Product introduction

SR-2818 RGBW remote controller is full touch remote controller which has 8 different zones. It can get Red/ Green/ Blue/ White color directly. The remote controller can save up to 8 colors or 8 modes into corresponding buttons (1-8 buttons) for each zone. You can choose any color through color wheel. There is a USB port to charge internal battery.

Parameter

Remote

Part No.	Operation Voltage	Operation Frequency	DIMENSIONS ø/h (mm)	Remarks
SR-2818	3.6VDC	434MHz/868MHz	59x115x12	Lithium battery, USB charging capability

Receiver

Part No.	Input Voltage	Current	Output	Remarks
SR-1009FA	12-36VDC	4x5A	4x(60-180)W	Constant voltage
SR-1009EA	12-36VDC	4x8A	4x(96-288)W	Constant voltage
SR-1009FA3	12-36VDC	4x350mA	4x(4.2-12.6)W	Constant current
SR-1009FA7	12-36VDC	4x700mA	4x(8.4-25.2)W	Constant current

Product Size

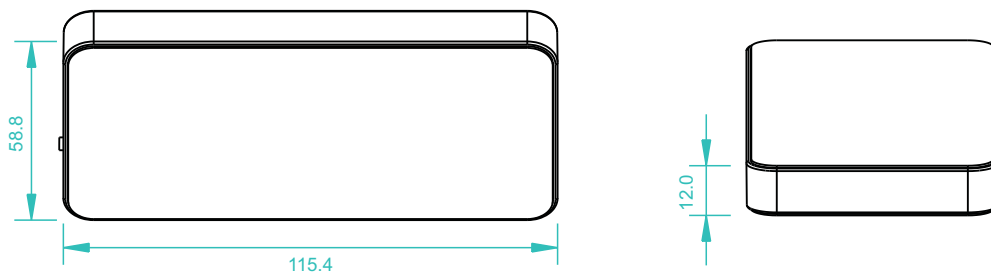

Brief introduction of buttons

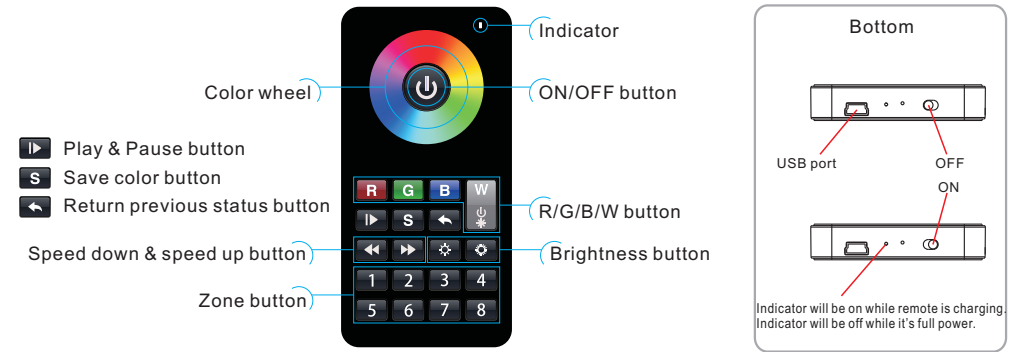

Wiring diagram

1)Receiver Connection Diagram for Single Unit

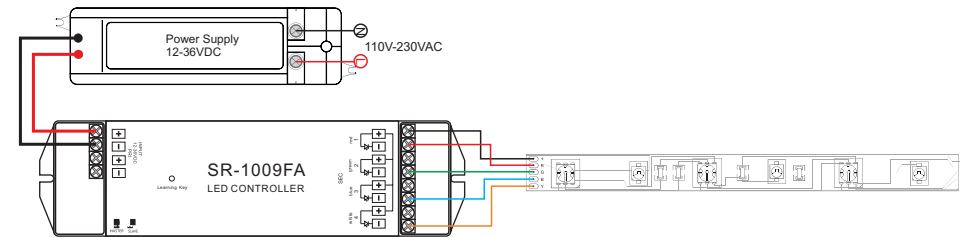

2)Receiver Connection Diagram for Multiple Units

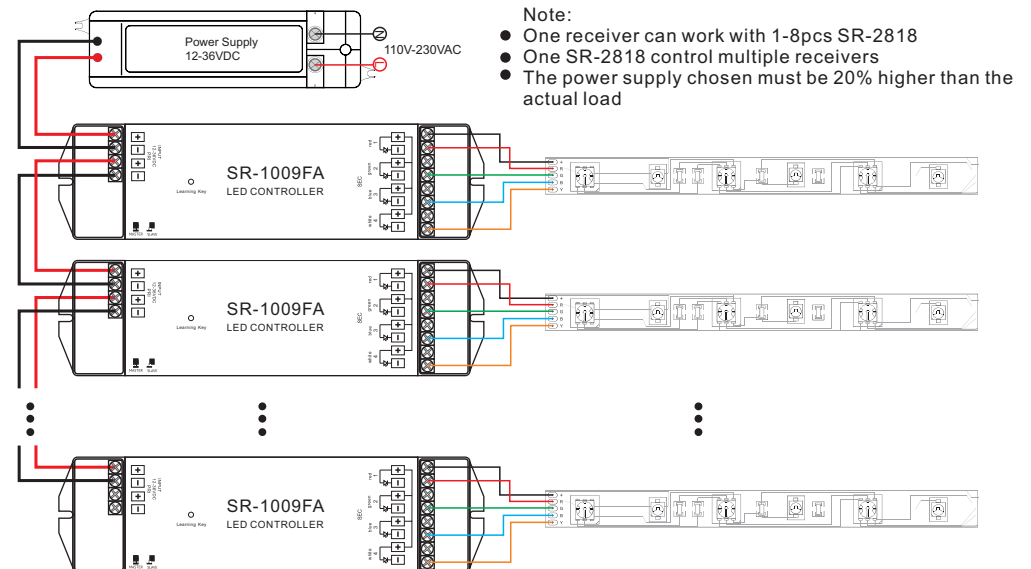

Operation

Learning (matching)

- Do wiring according to connection diagram
- Wake up the remote control by touching ON/OFF button.
- Press learning button on receiver.
- Touch any zone button on remote control.
- Then touch color wheel.
- Connected LED light will blink to confirm zone designation.
- Press at learning button on receiver over 5 seconds until LED light flash, then delete the learned ID.

Note 1: To choose a master from slaves by jumper for each zone.

Short circuit for master.

Open circuit for slave.

Each zone only can set one master controller. After a period of time, the master will do synchronization operation to keep the same color or mode of all slaves in one zone.

Note 2: Each remote control 8 zones (areas) receivers, each area can be learned as many receivers as we can.

Each receiver maximally can be controlled by 8 different remote controllers.

RGBW Button

Touch **R** **G** **B** **W** button is to switch on/off of each corresponding color.

Hold your finger on **R** **G** **B** **W** button to dim brightness of each corresponding color. There are total 8 levels of brightness.

Note: If you press R, then press G, then it is mix color of R and G. If you want to get G color directly, please press R to switch off of R first. Then press G.

Running&Pause Button

- Press pause&run button . mode will run. Press it once, it runs one mode. Press button again, it stops, then press one more time, it will enter next mode. There are total 10 build-in modes.
- Pause&run button can work with button **S**, it can save modes into different zone.
- Touch button **1** **2** **3** **4** one by one, such as press button 1,2,3,4,5,6, then **5** **6** **7** **8**

Press  button. 1,2,3,4,5,6 will run synchronized mode, after long press, LED lighting will flash twice, they will switch to chasing running mode, long press again to switch back.

Return button

Touch  button to return previous color or running mode.

Speed up and Speed down Button

Touch button  to speed down when mode is running, touch button  to speed up when mode is running.

Brightness down or up button

Long touch button  to dim down brightness of RGB channels, Long touch  button to dim up RGB channels.

"W" channel is separated from RGB channels, so we can only long touch button to dimming "W" channel.

Save Button

- How to save color into different position per zone?

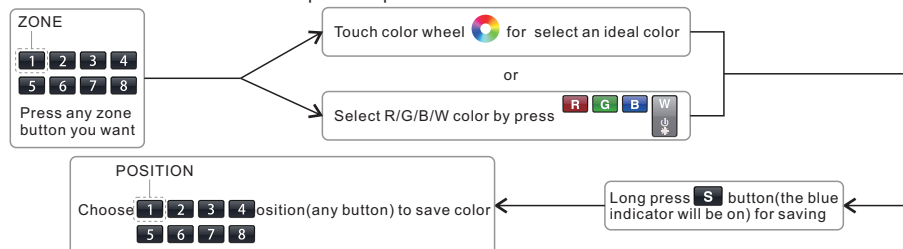

For example, press zone button 1, then touch color wheel for orange color, then press S button (the blue indicator will be on), then choose position button 3. That's to say, we save orange color from zone 1 into position 3. So each zone can save 8 colors. 8 zones can save 64 colors.

b. How to save mode into different position per zone?

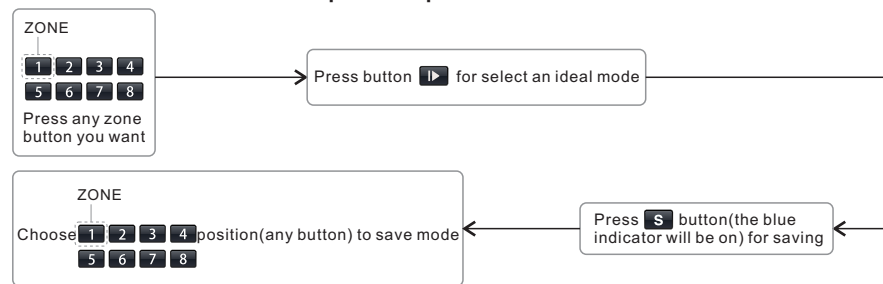

c. Recall

Choose zone number form **1** **2** **3** **4**, then press **S** button, and press the position button which color or mode saved into. **5** **6** **7** **8**

Safety & Warnings

- The product shall be installed and serviced by a qualified person.
- IP20. Please avoid the sun and rain. When installed outdoors, please ensure it is mounted in a water proof enclosure.
- Always be sure to mount this unit in an area with proper ventilation to avoid overheating.
- Please check if the output voltage of any LED power supplies used comply with the working voltage of the product.
- Never connect any cables while power is on and always assure correct connections to avoid short circuits before switching on.
- Please ensure that the cable is secured tightly in the connector
- For update information please consult your supplier.

Warranty Agreement

- We provide lifelong technical assistance with this product:

- 3-year warranty. We print date on every products, for example :1125 means year 2011, week 25. The warranty is for free repair or replacement and covers manufacturing faults only.

- For faults beyond the 3-year warranty we reserve the right to charge for time and parts.

- Limited Warranty

- Any defects caused by wrong operation.

- Any damages caused by unauthorized removal, maintenance, modifying, incorrect connection and replacement of chips.

- Any damages due to transportation, vibration etc. after purchase.

- Any damages caused by earthquake, fire, lightning, pollution and abnormal voltage.

- Any damages caused by negligence, inappropriate storing at high temperatures and humidity or near harmful chemicals.

- Product has been updated

- Repair or replacement as provided under this warranty is the exclusive remedy to the customer.